

ControlLogix System

Catalog Numbers 1756 series

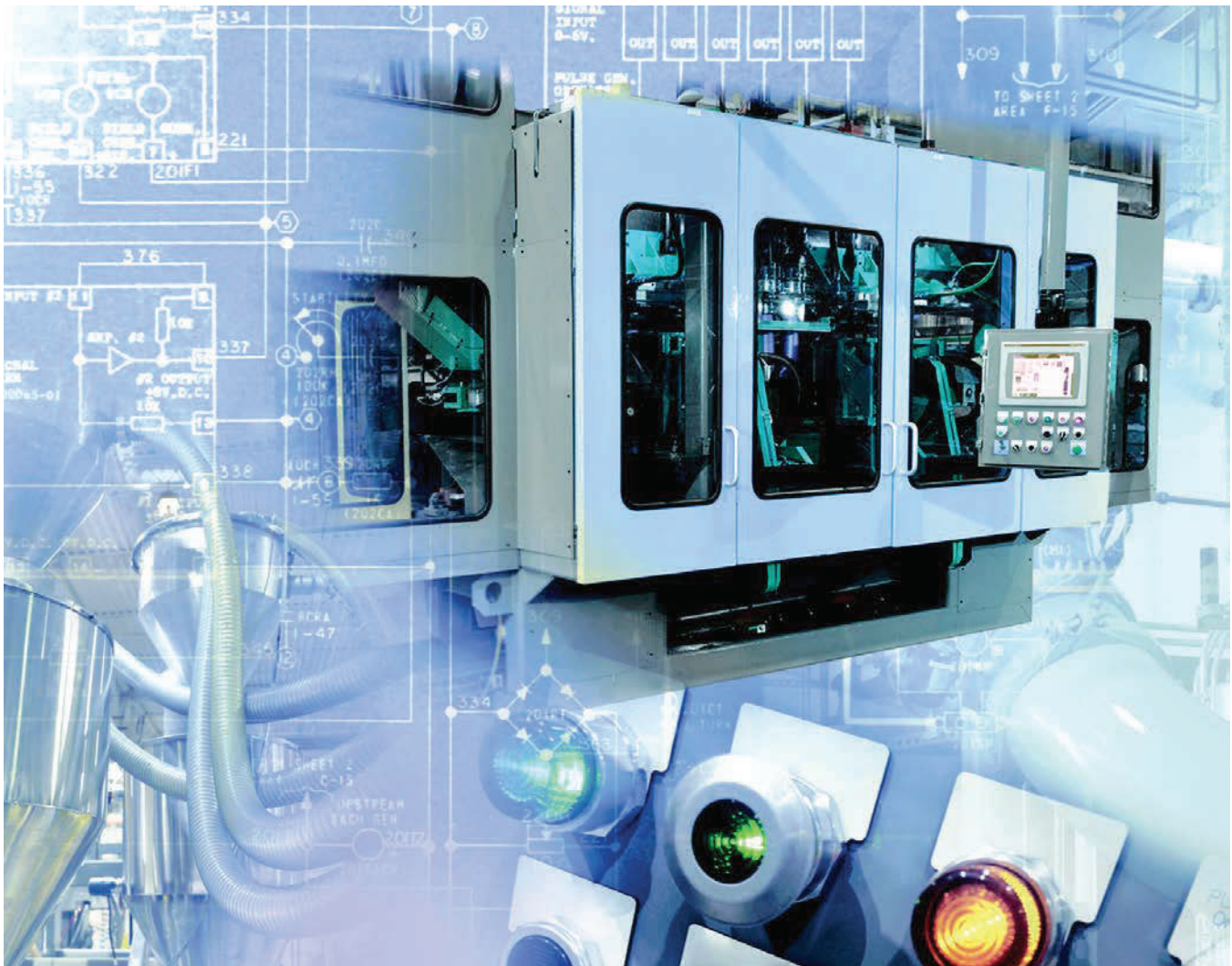

[1756 ControlLogix I/O Modules](#)

[1756 ControlLogix Integrated Motion](#)

[1756 ControlLogix Communication Modules](#)

[1756 ControlLogix Controllers](#)

[1756 ControlLogix Chassis](#)

[1756 ControlLogix Power Supplies](#)

LISTEN.
THINK.
SOLVE.®

Logix Controllers Comparison

Characteristic	1756 ControlLogix® 1756-L71, 1756-L72, 1756-L73, 1756-L73XT, 1756-L74, 1756-L75 1756 GuardLogix® 1756-L71S, 1756-L72S, 1756-L73S	1756 ControlLogix 1756-L61, 1756-L62, 1756-L63, 1756-L63XT, 1756-L64, 1756-L65 1756 GuardLogix 1756-L61S, 1756-L62S, 1756-L63S	CompactLogix™ 1769-L30ER, 1769-L30ER-NSE, 1769-L30ERM, 1769-L33ER, 1769-L33ERM, 1769-L36ERM	CompactLogix 1769-L24ER-BB1B, 1769-L24ER-QBFC1B, 1769-L27ERM-QBFC1B	CompactLogix 1769-L16ER-BB1B, 1769-L18ER-BB1B, 1769-L18ERM-BB1B
Controller tasks:	<ul style="list-style-type: none"> 32; 100 programs/task 	<ul style="list-style-type: none"> 32; 100 programs/task 	<ul style="list-style-type: none"> 32; 100 programs/task 	<ul style="list-style-type: none"> 32; 100 programs/task 	<ul style="list-style-type: none"> 32; 100 programs/task
Event tasks	All event triggers	All event triggers	Consumed tag, EVENT instruction triggers and motion events	Consumed tag, EVENT instruction triggers and motion events	Consumed tag, EVENT instruction triggers and motion events
User memory	<ul style="list-style-type: none"> 1756-L71: 2 MB 1756-L72: 4 MB 1756-L73: 8 MB 1756-L73XT: 8 MB 1756-L74: 16 MB 1756-L75: 32 MB 1756-L71S: 2 MB + 1 MB safety 1756-L72S: 4 MB + 2 MB safety 1756-L73S: 8 MB + 4 MB safety 	<ul style="list-style-type: none"> 1756-L61: 2 MB 1756-L62: 4 MB 1756-L63: 8 MB 1756-L63XT: 8 MB 1756-L64: 16 MB 1756-L65: 32 MB 1756-L61S: 2 MB + 1 MB safety 1756-L62S: 4 MB + 1 MB safety 1756-L63S: 8 MB + 3.75 MB safety 	<ul style="list-style-type: none"> 1769-L30ER, 1769-L30ER-NSE, 1769-L30ERM: 1MB 1769-L33ER, 1769-L33ERM: 2 MB 1769-L36ERM: 3 MB 	<ul style="list-style-type: none"> 1769-L24ER: 750 KB 1769-L27ERM: 1 MB 	<ul style="list-style-type: none"> 1769-L16ER: 384 KB 1769-L18ER, 1769-L18ERM: 512 KB
Memory card	Secure Digital	CompactFlash	Secure Digital	Secure Digital	Secure Digital
Built-in ports	1 port USB	1 port RS-232 serial	<ul style="list-style-type: none"> Dual-port EtherNet/IP 1 port USB 	<ul style="list-style-type: none"> Dual-port EtherNet/IP 1 port USB 	<ul style="list-style-type: none"> Dual-port EtherNet/IP 1 port USB
Communication options	<ul style="list-style-type: none"> EtherNet/IP ControlNet DeviceNet Data Highway Plus Remote I/O SynchLink USB 	<ul style="list-style-type: none"> EtherNet/IP ControlNet DeviceNet Data Highway Plus Remote I/O SynchLink 	<ul style="list-style-type: none"> EtherNet/IP <ul style="list-style-type: none"> Embedded switch Single IP address DeviceNet USB 	<ul style="list-style-type: none"> EtherNet/IP <ul style="list-style-type: none"> Embedded switch Single IP address DeviceNet USB 	<ul style="list-style-type: none"> EtherNet/IP <ul style="list-style-type: none"> Embedded switch Single IP address USB
Controller connections	500	250 serial	256	256	256
Network connections	Per network module: <ul style="list-style-type: none"> 100 ControlNet (CN2/A) 40 ControlNet (CNB) 256 EtherNet/IP; 128 TCP (EN2x) 128 EtherNet/IP; 64 TCP (ENBT) 	Per network module: <ul style="list-style-type: none"> 100 ControlNet (CN2/A) 40 ControlNet (CNB) 256 EtherNet/IP; 128 TCP (EN2x) 128 EtherNet/IP; 64 TCP (ENBT) 	<ul style="list-style-type: none"> 1769-L30ER, 1769-L30ER-NSE, 1769-L30ERM: 16 EtherNet/IP; 120 TCP 1769-L33ER, 1769-L33ERM: 32 EtherNet/IP; 120 TCP 1769-L36ERM: 48 EtherNet/IP; 120 TCP 	<ul style="list-style-type: none"> 1769-L24ER-QB1B: 8 EtherNet/IP; 120 TCP 1769-24ER-BFC1B: 8 EtherNet/IP; 120 TCP 1769-L27ERM-QBFC1B: 16 EtherNet/IP; 120 TCP 	<ul style="list-style-type: none"> 1769-L16ER-BB1B 4 EtherNet/IP; 120 TCP 1769-L18ER-BB1B: 8 EtherNet/IP; 120 TCP 1769-L18ERM-BB1B: 8 EtherNet/IP; 120 TCP
Controller redundancy	Full support	Full support	Backup via DeviceNet	Backup via DeviceNet	None
Simple motion	<ul style="list-style-type: none"> Stepper Servo via DeviceNet Analog or networked AC drive 	<ul style="list-style-type: none"> Stepper Servo via DeviceNet Analog or networked AC drive 	<ul style="list-style-type: none"> Servo via DeviceNet Analog or Networked AC drive 	<ul style="list-style-type: none"> Servo via DeviceNet Analog or Networked AC drive 	Analog or Networked AC drive
Integrated motion	<ul style="list-style-type: none"> EtherNet/IP SERCOS interface Analog options: <ul style="list-style-type: none"> Encoder input LDT input SSI input 	<ul style="list-style-type: none"> EtherNet/IP SERCOS interface Analog options: <ul style="list-style-type: none"> Encoder input LDT input SSI input 	EtherNet/IP: 1769-L30ERM, 1769-L33ERM, 1769-L36ERM	EtherNet/IP: 1769-L27-ERM-QBFC1B	EtherNet/IP: 1769-L18ERM-BB1B
Programming languages	<ul style="list-style-type: none"> Relay ladder Structured text Function block Sequential function chart Safety task: relay ladder, safety application instructions 	<ul style="list-style-type: none"> Relay ladder Structured text Function block Sequential function chart Safety task: relay ladder, safety application instructions 	<ul style="list-style-type: none"> Relay ladder Structured text Function block Sequential function chart 	<ul style="list-style-type: none"> Relay ladder Structured text Function block Sequential function chart 	<ul style="list-style-type: none"> Relay ladder Structured text Function block Sequential function chart

Characteristic	1768 CompactLogix 1768-L43, 1768-L45 1768 Compact GuardLogix 1768-L43S, 1768-L45S	1769-L3x CompactLogix 1769-L31, 1769-L32x, 1769-L35x	1769-L23x CompactLogix 1769-L23	1789 SoftLogix™5800 1789-L10, 1789-L30, 1789-L60
Controller tasks: • Continuous • Periodic • Event	<ul style="list-style-type: none"> • 16; • 32 programs/task 	<ul style="list-style-type: none"> • 1769-L35x: 8 • 1769-L32x: 6 • 1769-L31: 4 • 32 programs/task 	<ul style="list-style-type: none"> • 3; • 16 programs/task 	<ul style="list-style-type: none"> • 32; • 100 programs/task
Event tasks	Consumed tag, EVENT instruction triggers and motion events	Consumed tag and EVENT instruction triggers	Consumed tag and EVENT instruction triggers	All event triggers, plus outbound and Windows events
User memory	<ul style="list-style-type: none"> • 1768-L43: 2 MB • 1768-L45: 3 MB • 1768-L43S: 2 MB +0.5 MB safety • 1768-L45S: 3 MB+1 MB safety 	<ul style="list-style-type: none"> • 1769-L31: 512 KB • 1769-L32x: 750 KB • 1769-L35x: 1.5 MB 	512 KB	<ul style="list-style-type: none"> • 1789-L10: 2 MB; 1 controller; no motion • 1789-L30: 64 MB; 3 controllers • 1789-L60: 64 MB; 6 controllers
Memory card	CompactFlash	CompactFlash	None	None
Built-in ports	1 RS-232	<ul style="list-style-type: none"> • 1769-L31: 2 RS-232 ports • 1769-L32C, 1769-L35CR: 1 ControlNet port and 1 RS-232 serial port • 1769-L32E, 1769-L35E: 1 EtherNet/IP port and 1 RS-232 serial port 	<ul style="list-style-type: none"> • 1769-L23E-QB1B: 1 EtherNet/IP port and 1 RS-232 serial port • 1769-L23E-QBFC1B: 1 EtherNet/IP port and 1 RS-232 serial port • 1769-L23-QBFC1B: 2 RS-232 serial ports 	Depends on personal computer
Communication options	<ul style="list-style-type: none"> • EtherNet/IP • DeviceNet • ControlNet 	<ul style="list-style-type: none"> • EtherNet/IP • DeviceNet • ControlNet 	<ul style="list-style-type: none"> • EtherNet/IP • DeviceNet 	<ul style="list-style-type: none"> • EtherNet/IP • DeviceNet • ControlNet
Controller connections	250	100	100	250
Network connections	Per network module: <ul style="list-style-type: none"> • 48 ControlNet • 128 EtherNet/IP; 64 TCP 	Per controller: <ul style="list-style-type: none"> • 32 ControlNet • 32 EtherNet/IP; 32 TCP 	Per controller: <ul style="list-style-type: none"> • 32 EtherNet/IP; 8 TCP 	Per network module: <ul style="list-style-type: none"> • 48 ControlNet • 128 EtherNet/IP; 64 TCP
Controller redundancy	Backup via DeviceNet	Backup via DeviceNet	Backup via DeviceNet	N/A
Simple motion	<ul style="list-style-type: none"> • Stepper • Servo via DeviceNet • Analog or networked AC drive 	<ul style="list-style-type: none"> • Stepper • Servo via DeviceNet • Analog or networked AC drive 	<ul style="list-style-type: none"> • Stepper • Servo via DeviceNet • Analog or networked AC drive 	<ul style="list-style-type: none"> • Stepper • Servo via DeviceNet • Analog or networked AC drive
Integrated motion	SERCOS interface	N/A	N/A	SERCOS interface Analog encoder input
Programming languages	<ul style="list-style-type: none"> • Relay ladder • Structured text • Function block • Sequential function chart • Safety task: relay ladder, safety application instructions 	<ul style="list-style-type: none"> • Relay ladder • Structured text • Function block • Sequential function chart 	<ul style="list-style-type: none"> • Relay ladder • Structured text • Function block • Sequential function chart 	<ul style="list-style-type: none"> • Relay ladder • Structured text • Function block • Sequential function chart • External routines developed in C or C++

Notes:

Select a ControlLogix System

1756 ControlLogix System



Step 1
[ControlLogix I/O Modules](#)
Page 10

- Select:
- I/O modules—Some modules have field-side diagnostics, electronic fusing, or individually isolated inputs/outputs
 - A remote terminal block (RTB) or wiring system for each I/O module

Step 2
[ControlLogix Integrated Motion](#)
Page 17

- Select:
- An EtherNet/IP communication module for Integrated Motion
 - A SERCOS or analog interface module
 - Associated cables
 - A removable terminal block (RTB)—only for analog interface modules
 - Select drives, motors, and accessories (use the Motion Analyzer software)

Step 3
[ControlLogix Communication Modules](#)
Page 19

- Select:
- Networks
 - Communication modules
 - Associated cables and network equipment
 - Sufficient modules and cables if you are planning a redundant system

Step 4
[ControlLogix Controllers](#)
Page 27

- Select:
- A controller with sufficient memory
 - Memory card
 - Replacement batteries, if needed

Step 5
[ControlLogix Chassis](#)
Page 32

- Select:
- A chassis with sufficient slots
 - Slot fillers for empty slots

Step 6
[ControlLogix Power Supplies](#)
Page 33

- Select:
- One power supply for each chassis, if you are using standard power supplies
 - A power supply bundle if you are planning a redundant power supply system

Optional Step
[Visualization Products](#)
Page 34

Optional Step
[Programming Software](#)
Page 35

ControlLogix System Overview

The ControlLogix system provides discrete, drives, motion, process, and safety control together with communication and state-of-the-art I/O in a small, cost-competitive package. The system is modular, so you can design, build, and modify it efficiently with significant savings in training and engineering.

Example Configuration—ControlLogix System

A simple ControlLogix system consists of a standalone controller and I/O modules in a single chassis. For a more comprehensive system, use the following:

- Multiple controllers in a single chassis
- Multiple controllers joined across networks
- I/O in multiple platforms that are distributed in many locations and connected over multiple I/O links

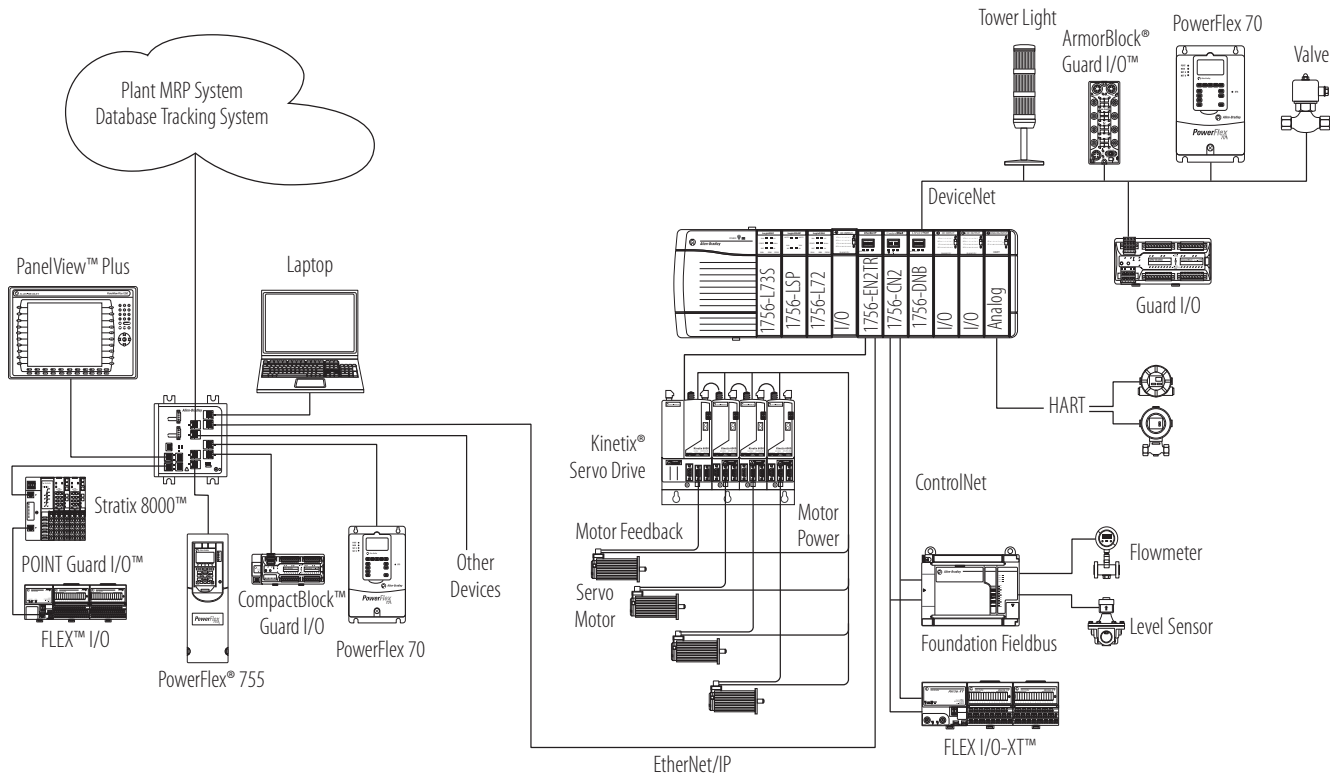

ControlLogix-XT System

ControlLogix-XT™ controllers function the same way as traditional ControlLogix controllers. The ControlLogix-XT products include control and communication system components that are conformally coated to extend product life in harsh, corrosive environments:

- When used with FLEX I/O-XT products, the ControlLogix-XT system can withstand temperatures range from -20...70 °C (-4...158 °F).
- When used independently, the ControlLogix-XT system can withstand temperature ranges from -25...70 °C (-13...158 °F).

GuardLogix Safety System

A GuardLogix controller is a ControlLogix controller that also provides safety control. The GuardLogix system is a dual controller solution—you must use a GuardLogix controller with the appropriate safety partner to achieve SIL 3/PLe/Cat. 4. A major benefit of this system is that it is still a single project, safety, and standard together. The safety partner controller is a part of the system, is automatically configured, and requires no user setup.

Application	Description
Up to and including SIL 3	<p>The GuardLogix controller system is type-approved and certified for use in safety applications up to and including SIL 3, according to IEC 61508, and applications up to and including category (PLe/Cat. 4), according to ISO 13849-1.</p> <p>For more information, see the following:</p> <ul style="list-style-type: none"> • GuardLogix Controllers Systems Safety Reference Manual, publication 1756-RM093 • GuardLogix Controllers User Manual, publication 1756-UM020 • GuardLogix Safety Application Instruction Set Reference Manual, publication 1756-RM095
SIL 2	<p>Components of the ControlLogix system are type-approved and certified for use in SIL 2 applications, according to IEC 61508.</p> <p>For a list of ControlLogix system components that meet SIL 2 requirements, see the Using ControlLogix in SIL 2 Applications Safety Reference Manual, publication 1756-RM001.</p>

Example Configuration—Redundant ControlLogix System

The ControlLogix controller supports controller redundancy.

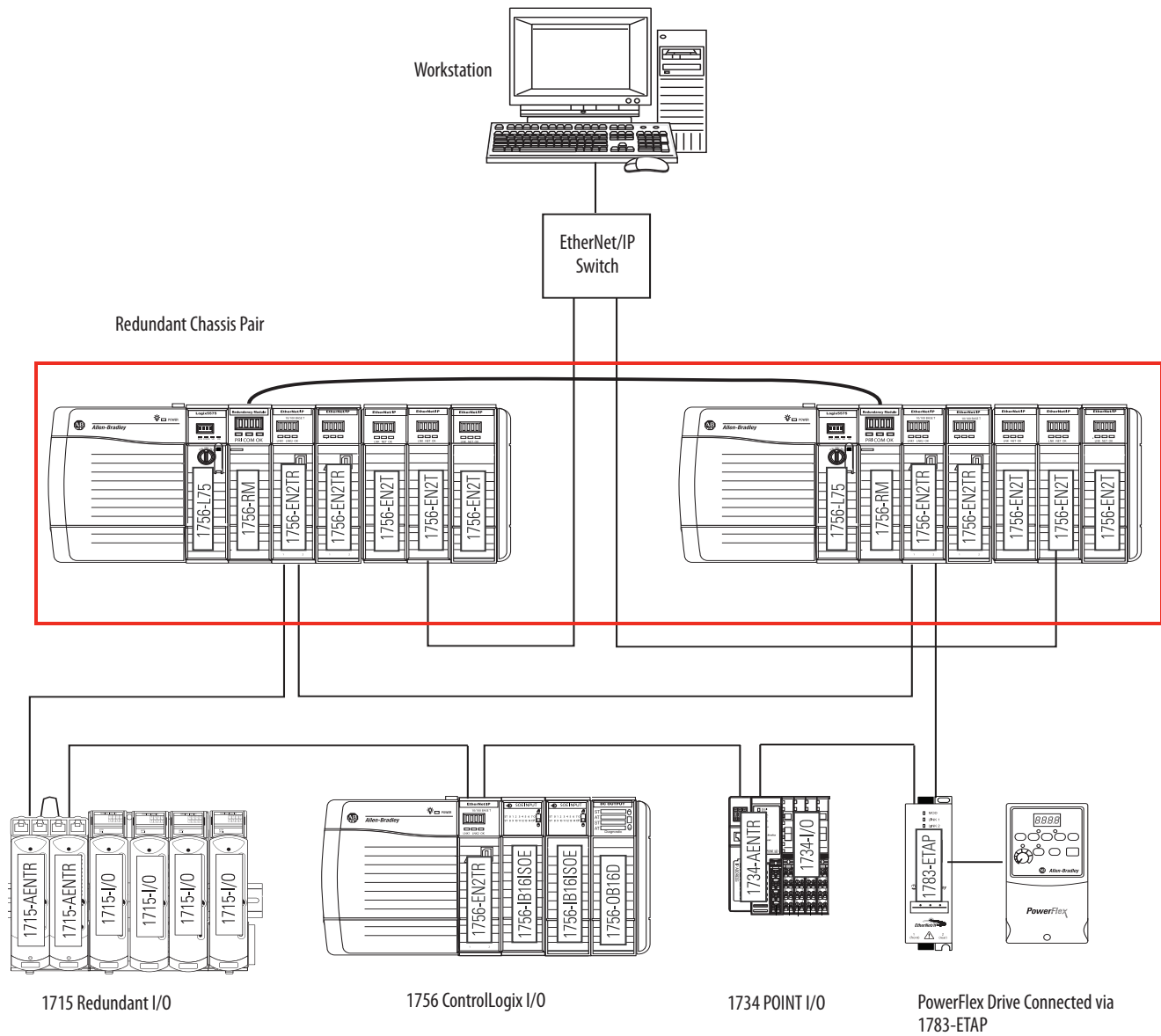

Example Configuration—Redundant I/O System

The 1715 redundant I/O system lets a ControlLogix controller communicate to a remote, redundant I/O chassis over an EtherNet/IP network. The 1715 redundant I/O system provides fault tolerance and redundancy for critical processes by using a redundant adapter pair and redundant I/O module pairs.

The redundant I/O system must be connected to a ControlLogix system via an EtherNet/IP network. All connections are established via the Ethernet network by using the topologies supported by the 1756-EN2TR communication bridge.

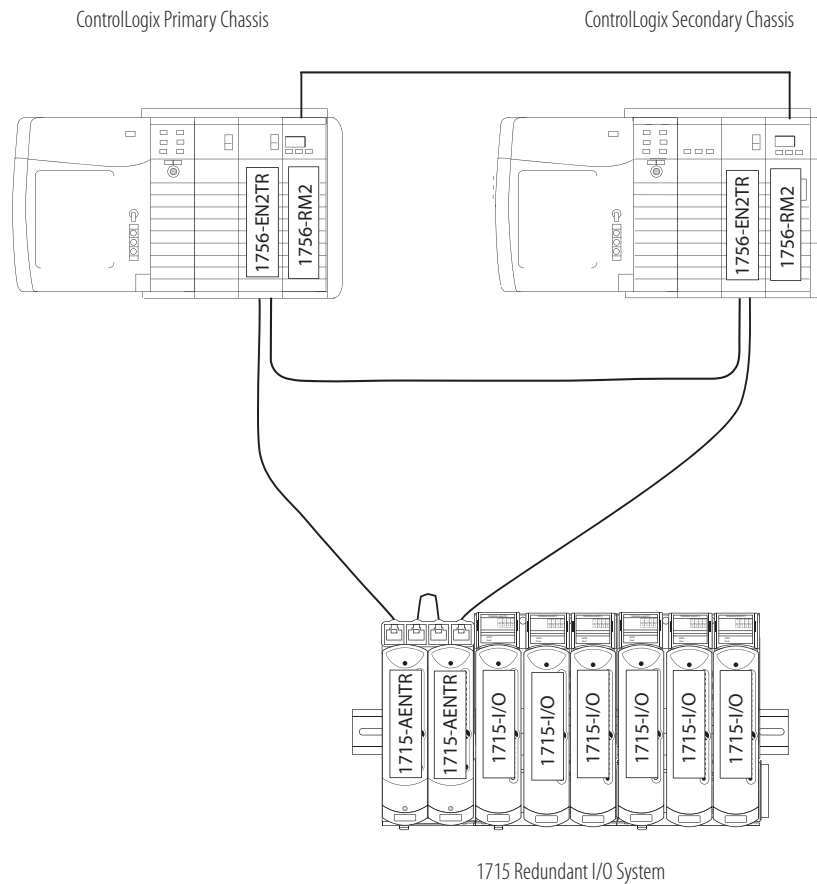

For detailed specifications, see the 1715 Redundant I/O System Specifications Technical Data, publication [1715-TD001](#).

ControlLogix I/O Modules

The ControlLogix architecture provides a wide range of input and output modules to span many applications, from high-speed digital to process control. The ControlLogix architecture uses a producer/consumer model so that input information and output status can be shared among multiple controllers.

Each ControlLogix I/O module mounts in a ControlLogix chassis and **requires** either a removable terminal block (RTB) or a 1492 interface module (IFM) to connect all field-side wiring. RTBs and IFMs are not included with the I/O modules. They must be ordered separately.

For detailed specifications, see 1756 ControlLogix I/O Modules Specifications Technical Data, publication [1756-TD002](#).

AC Digital Input Modules

Cat. No.	Inputs/Outputs	Voltage Category	Operating Voltage Range	Removable Terminal Block
1756-IA8D	8 diagnostic inputs (4 points/group)	120V AC	79...132V AC	1756-TBNH 1756-TBSH
1756-IA16	16 inputs (8 points/group)	120V AC	74...132V AC	1756-TBNH 1756-TBSH
1756-IA16I	16 individually isolated inputs	120V AC	74...132V AC	1756-TBCH 1756-TBS6H
1756-IA32	32 diagnostic inputs (4 points/group)	120V AC	74...132V AC	1756-TBCH 1756-TBS6H
1756-IM16I	16 individually isolated inputs	240V AC	159...265V AC	1756-TBCH 1756-TBS6H
1756-IN16	16 inputs (8 points/group)	24V AC	10...30V AC	1756-TBNH 1756-TBSH

AC Digital Output Modules

Cat. No.	Inputs/Outputs	Voltage Category	Operating Voltage Range	Removable Terminal Block
1756-OA8	8 outputs (4 points/group)	120/240V AC	79...265V AC	1756-TBNH 1756-TBSH
1756-OA8D	8 diagnostic, electronically fused outputs (4 points/group)	120V AC	74...132V AC	1756-TBNH 1756-TBSH
1756-OA8E	8 electronically fused outputs (4 points/group)	120V AC	74...132V AC	1756-TBNH 1756-TBSH
1756-OA16	16 mechanically fused/group outputs (8 points/group)	120/240V AC	74...265V AC	1756-TBNH 1756-TBSH
1756-OA16I	16 individually isolated outputs	120/240V AC	74...265V AC	1756-TBCH 1756-TBS6H
1756-ON8	8 outputs (4 points/group)	24V AC	10...30V AC, current > 50 mA 16...30V AC, current < 50 mA	1756-TBNH 1756-TBSH

DC Digital Input Modules

Cat. No.	Inputs/Outputs	Voltage Category	Operating Voltage Range	Removable Terminal Block
1756-IB16	16 inputs (8 points/group)	12/24V DC sink	10...31.2V DC	1756-TBNH 1756-TBSH
1756-IB16D	16 diagnostic inputs (4 points/group)	12/24V DC sink	10...30V DC	1756-TBCH 1756-TBS6H
1756-IB16I	16 individually isolated inputs	12/24V DC sink/source	10...30V DC	1756-TBCH 1756-TBS6H
1756-IB16IF	16 high-speed, individually isolated inputs	12/24V DC sink/source	10...30V DC	1756-TBCH 1756-TBS6H
1756-IB16ISOE	16 individually isolated, sequence of events inputs	24/48V DC sink/source	10...55V DC	1756-TBCH 1756-TBS6H
1756-IB32	32 inputs (16 points/group)	12/24V DC sink	10...31.2V DC	1756-TBCH 1756-TBS6H
1756-IC16	16 inputs (8 points/group)	48V DC sink	30...55V DC @ 60 °C (140 °C) 30...60V DC @ 55 °C (131 °C)	1756-TBNH 1756-TBSH
1756-IG16	16 inputs (8 points/group)	5V DC TTL source (Low = True)	4.5...5.5V DC	1756-TBNH 1756-TBSH
1756-IH16I	16 individually isolated inputs	125V DC sink/source	90...146V DC	1756-TBCH 1756-TBS6H
1756-IH16ISOE	16 individually isolated, sequence of events inputs	125V DC sink/source	90...140V DC	1756-TBCH 1756-TBS6H
1756-IV16	16 inputs (8 points/group)	12/24V DC source	10...30V DC	1756-TBNH 1756-TBSH
1756-IV32	32 inputs (16 points/group)	12/24V DC source	10...30V DC	1756-TBCH 1756-TBS6H

DC Digital Output Modules

Cat. No.	Inputs/Outputs	Voltage Category	Operating Voltage Range	Removable Terminal Block
1756-0B8	8 outputs	12/24V DC source	10...30V DC	1756-TBNH 1756-TBSH
1756-0B8EI	8 electronically fused, individually isolated outputs	12/24V DC source	10...30V DC	1756-TBCH 1756-TBS6H
1756-0B8I	8 individually isolated outputs	12/24V DC source	10...30V DC	1756-TBCH 1756-TBS6H
1756-0B16D	16 diagnostic outputs (8 points/group)	24V DC source	19.2...30V DC	1756-TBCH 1756-TBS6H
1756-0B16E	16 electronically fused outputs (8 points/group)	12/24V DC source	10...31.2V DC	1756-TBNH 1756-TBSH
1756-0B16I	16 individually isolated outputs	12/24V DC sink/source	10...30V DC	1756-TBCH 1756-TBS6H
1756-0B16IEF	16 high-speed, individually isolated, electronically-fused outputs	24V DC sink/source	10...30V DC	1756-TBCH 1756-TBS6H
1756-0B16IEFS	16 scheduled, high-speed, individually isolated, electronically-fused outputs	24V DC sink/source	10...30V DC	1756-TBCH 1756-TBS6H
1756-0B16IS	16 individually isolated outputs 8 scheduled outputs	12/24V DC sink/source	10...30V DC	1756-TBCH 1756-TBS6H
1756-0B32	32 outputs (16 points/group)	12/24V DC source	10...31.2V DC	1756-TBCH 1756-TBS6H
1756-0C8	8 outputs (4 points/group)	48V DC source	30...60V DC	1756-TBNH 1756-TBSH
1756-0G16	16 (8 points/group)	5V DC TTL source (Low=True)	4.5...5.5V DC	1756-TBNH 1756-TBSH
1756-0H8I	8 individually isolated outputs	120V DC	90...146V DC	1756-TBCH 1756-TBS6H
1756-0V16E	16 electronically fused outputs (8 points/group)	12/24V DC sink	10...30V DC	1756-TBNH 1756-TBSH
1756-0V32E	32 electronically fused outputs (16 points/group)	12/24V DC sink	10...30V DC	1756-TBCH 1756-TBS6H

Contact Output Modules

Cat. No.	Inputs/Outputs	Operating Voltage Range	Removable Terminal Block
1756-0W16I	16 normally open, individually isolated outputs	5...150V DC 10...265V AC	1756-TBCH 1756-TBS6H
1756-0X8I	8 normally open 8 normally closed, individually isolated outputs (2 points/group)	5...150V DC 10...265V AC	1756-TBCH 1756-TBS6H

Analog Input Modules

Cat. No.	Inputs/Outputs	Range	Resolution	Removable Terminal Block
1756-IF6CIS	6 individually isolated inputs, current sourcing	0...21 mA	16 bits 0.34 μ A/bit	1756-TBNH 1756-TBSH
1756-IF6I	6 individually isolated inputs	\pm 10.5V 0...10.5V 0...5.25V 0...21 mA	16 bits 10.5V: 343 μ V/bit 0...10.5V: 171 μ V/bit 0...5.25V: 86 μ V/bit 0...21 mA: 0.34 μ A/bit	1756-TBNH 1756-TBSH
1756-IF8	8 single-ended inputs 4 differential inputs 2 high-speed differential inputs	\pm 10.25V 0...10.25V 0...5.125V 0...20.5 mA	\pm 10.25V: 320 μ V/cnt (15 bits plus sign bipolar) 0...10.25V: 160 μ V/cnt (16 bits) 0...5.125V: 80 μ V/cnt (16 bits) 0...20.5 mA: 0.32 μ A/cnt (16 bits)	1756-TBCH 1756-TBS6H
1756-IF8H	8 differential voltage or current inputs, HART interface	\pm 10V 0...5V 1...5V 0...10V 0...20 mA 4...20 mA	16...21 bits	1756-TBCH 1756-TBS6H
1756-IF16	16 single-ended inputs 8 differential or 4 differential (high speed) inputs	\pm 10.5V 0...10.5V 0...5.25V 0...21 mA	16 bits 10.5V: 343 μ V/bit 0...10.5V: 171 μ V/bit 0...5.25V: 86 μ V/bit 0...21 mA: 0.34 μ A/bit	1756-TBCH 1756-TBS6H
1756-IF16H	16 differential current inputs, HART interface	0...20 mA 4...20 mA	16...21 bits	1756-TBCH 1756-TBS6H

Analog RTD and Thermocouple Modules

Cat. No.	Inputs/Outputs	Range	Resolution	Removable Terminal Block
1756-IR6I	6 individually isolated RTD inputs	1...487 Ω 2...1000 Ω 4...2000 Ω 8...4020 Ω	16 bits 1...487 Ω : 7.7 m Ω /bit 2...1000 Ω : 15 m Ω /bit 4...2000 Ω : 30 m Ω /bit 8...4020 Ω : 60 m Ω /bit	1756-TBNH 1756-TBSH
1756-IT6I	6 individually isolated thermocouple inputs 1 CJC	-12...78 mV -12...30 mV	16 bits -12...78 mV: 1.4 μ V/bit -12...30 mV: 0.7 μ V/bit	1756-TBNH 1756-TBSH
1756-IT6I2	6 individually isolated thermocouple inputs 2 CJC	-12...78 mV (1.4 μ V per bit) -12...30 mV (0.7 μ V per bit, high-resolution range)	16 bits -12...78 mV: 1.4 μ V/bit -12...30 mV: 0.7 μ V/bit	1756-TBNH 1756-TBSH

Analog Output Modules

Cat. No.	Inputs/Outputs	Range	Resolution	Removable Terminal Block
1756-OF4	4 voltage or current outputs	$\pm 10.4V$ 0...21 mA	Voltage: 15 bits across 10.5V, 320 μV /bit Current: 15 bits across 21 mA, 650 nA/bit	1756-TBNH 1756-TBSH
1756-OF6CI	6 individually isolated outputs, current	0...21 mA	13 bits across 21 mA (2.7 μA)	1756-TBNH 1756-TBSH
1756-OF6VI	6 individually isolated outputs, voltage	$\pm 10.5V$	14 bits across 21V (1.3 mV) (13 bits across 10.5V +sign bit)	1756-TBNH 1756-TBSH
1756-OF8	8 voltage or current outputs	$\pm 10.4V$ 0...21 mA	15 bits across 21 mA - 650 nA/bit 15 bits across 10.4V - 320 μV /bit	1756-TBNH 1756-TBSH
1756-OF8H	8 voltage or current outputs, HART interface	$\pm 10.4V$ 0...20 mA 4...20 mA	15...16 bits	1756-TBNH 1756-TBSH

Analog Combination Input and Output Module

Cat. No.	Inputs/Outputs	Range	Resolution	Removable Terminal Block
1756-IF4FXOF2F	4 high-speed, sub-millisecond, differential inputs 2 high-speed voltage or current outputs	Input: $\pm 10.5V$ 0...10.5V 0...5.25V 0...21 mA Output: $\pm 10.4V$ 0...21 mA	Input: Approx. 14 bits across $\pm 10V$ DC (21V total) $\pm 10V$: 1.3 mV/bit, 14-bit effective 0...10.5V: 1.3 mV/bit, 13-bit effective 0...5.25V: 1.3 mV/bit, 12-bit effective Approx. 12 bits across 21 mA 0...21 mA: 5.25 μA /bit Output: 13 bits across 21 mA = 2.8 μA /bit 14 bits across 21.8V = 1.3 mV/bit	1756-TBCH 1756-TBS6H

Specialty I/O Modules

Cat. No.	Inputs/Outputs	Description	Removable Terminal Block
1756-CFM	4 inputs (2 per channel) 2 outputs, current sourcing	Configurable flowmeter module 2 Flowmeter (F) inputs used for all modes 2 Gate inputs used in Totalizer mode for prover/store count	1756-TBNH 1756-TBSH
1756-HSC	2 counters, each with 3 inputs (A, B, Z for gate/reset) 4 outputs (2 points/group)	High-speed counter module 5V operation: 4.5...5.5V DC 12/24V operation: 10...31.2V DC	1756-TBCH 1756-TBS6H
1756-LSC8XIB8I	8...24V DC counters 8 high-speed 24V DC inputs	Low speed counter module 8...40 kHz 24V DC counters 8 high-speed 24V DC auxiliary inputs	1756-TBCH 1756-TBS6H
1756-PLS	Left section: 2 groups of 4 outputs and 4 inputs each Center section: resolver interface and I/O control Right section: 2 groups of 4 outputs and 4 inputs each	Programmable limit switch module	Requires 3 RTBs: 1756-TBNH or 1756-TBSH

HART Smart Instrumentation

HART (Highway Addressable Remote Transmitter) is an open protocol designed to connect analog devices. For HART connectivity, select products available from Rockwell Automation and our Encompass™ partners.

Typical HART Configuration

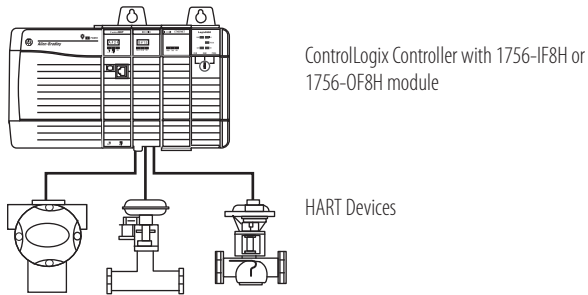

HART Interfaces

If your application has	Select	Description
Analog and HART connectivity in one module No external hardware required to access HART signal HART commands can be transmitted as unscheduled messages Supports asset management software to HART device	1756-IF8H 1756-IF16H 1756-OF8H	Rockwell Automation analog I/O modules
Data acquisition or control application with slow update requirements (such as a tank farm) No external hardware required to access HART signal Does not connect directly to asset management software	MVI56-HART	Prosoft interface
Analog and HART in one module Instrumentation in hazardous locations (FLEX Ex™ modules) HART commands can be transmitted as unscheduled messages Directly connects asset management software to HART devices	1794 FLEX I/O 1797 FLEX Ex I/O	There are specific FLEX I/O and FLEX Ex modules designed for HART systems. These catalog numbers end in an H, such as 1797-IE8H.

Accessories—I/O Modules

1756 Removable Terminal Blocks

Removable terminal blocks (RTBs) provide a flexible interconnection between your plant wiring and 1756 I/O modules. The RTB plugs into the front of the I/O module. The type of module determines which RTB you need. You can choose screw-clamp or spring-clamp RTBs.

RTBs are not shipped with I/O modules. You must order them separately. The standard housing on the front of the wiring arm is not deep enough for 2.5 mm² (14 AWG) wiring. If you plan to use 2.5 mm² (14 AWG) wiring, also order the extended housing.



Attribute	1756-TBNH	1756-TBSH	1756-TBCH	1756-TBS6H	1756-TBE
Description	20-position NEMA screw-clamp removable block	20-pin spring-clamp removable terminal block with standard housing	36-pin cage-clamp removable terminal block with standard housing	36-pin spring-clamp removable terminal block with standard housing	Extended depth terminal block housing
Screw torque	0.8...1 N•m 7...9 lb•in		0.4 N•m 4.4 lb•in		—

Wiring Systems

As an alternative to buying RTBs and connecting the wires yourself, you can buy a wiring system of the following:

- Interface modules (IFMs) that provide the I/O terminal blocks for digital I/O modules. Use the pre-wired cables that match the I/O module to the IFM.
- Analog interface modules (AIFMs) that provide the I/O terminal blocks for analog I/O modules. Use the pre-wired cables that match the I/O module to the AIFM.
- I/O module-ready cables. One end of the cable assembly is an RTB that plugs into the front of the I/O module. The other end has individually color-coded conductors that connect to a standard terminal block.

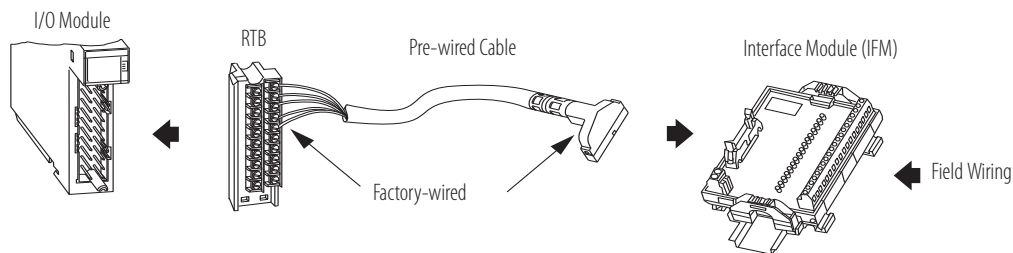

ControlLogix Integrated Motion

The Logix architecture supports motion control components that work in a wide variety of machine architectures:

- Integrated motion on the EtherNet/IP network supports a connection to Ethernet drives.
- The Kinetix integrated-motion solution uses a SERCOS or EtherNet/IP interface to perform multi-axis, synchronized motion.
- Logix integrated motion supports the analog family of servo modules for controlling drives/actuators.
- Networked motion provides the ability to connect via the DeviceNet network to a single axis drive to perform point-to-point indexing.

For detailed specifications on motion interface modules, see the 1756 ControlLogix Integrated Motion Specifications Technical Data, publication [1756-TD004](#).

For more information, see these publications:

- Motion Analyzer CD to size your motion application and to make final component selection
Download the software from <http://www.ab.com/motion/software/analyzer.html>
- Kinetix Motion Control Selection Guide, publication [GMC-SG001](#), to verify drive, motor, and accessory specifications

Integrated Motion on an EtherNet/IP Network

Product	Consideration
Drive that supports EtherNet/IP connections	Unlimited velocity, torque, and VHz configured drives: <ul style="list-style-type: none"> • Kinetix 6500 drives • Kinetix 5500 drives • Kinetix 350 drives • PowerFlex 755 drives
ControlLogix controller	As many as 100 drives per controller
ControlLogix EtherNet/IP communication module	<ul style="list-style-type: none"> • 1 . . . 8 position loop axes configured with the 1756-EN2TR module • 1 . . . 128 position loop axes configured with the 1756-EN3TR module

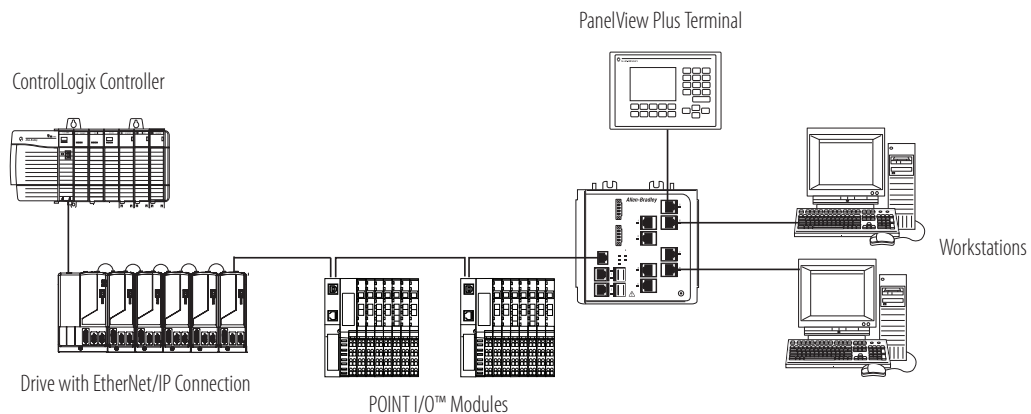

SERCOS Interface Modules

Cat. No.	Description	Number of Axes
1756-M16SE	Rockwell Automation® SERCOS interface modules	16
1756-M08SE		8
1756-M03SE		3
1756-M08SEG	SERCOS interface drives that are Extended Pack Profile compliant	8

The SERCOS interface modules can connect to these servo drives:

- 2093 Kinetix 2000 multi-axis servo drive
- 2094 Kinetix 6000 multi-axis servo drive
- 2099 Kinetix 7000 high-power servo drive
- 2098 Ultra™3000 SERCOS servo drive

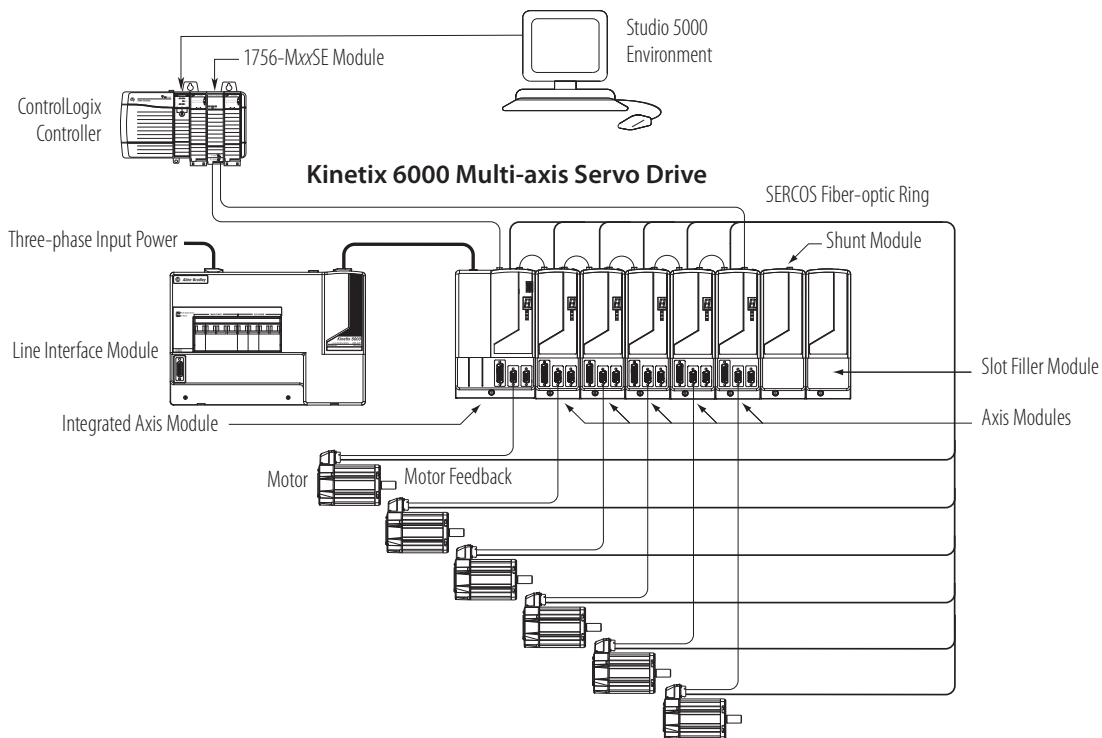

Analog Motion Interface Modules

Cat. No.	Description	Number of Axes
1756-M02AE	Analog servo interface drives with quadrature feedback	2
1756-HYD02	Analog, hydraulic servo interface drives LDT feedback	2
1756-M02AS	Analog servo interface drives with SSI feedback	2

ControlLogix Communication Modules

Separate communication modules are available for different networks. Install multiple communication modules into the ControlLogix backplane to bridge or route control and information data between different networks. You can route a message through a maximum of four chassis (eight communication hops). You do not need a ControlLogix controller in the chassis.

Application	Network	Page
<ul style="list-style-type: none"> Plant management (material handling) Configuration, data collection, and control on a single, high-speed network Time-critical applications with no established schedule Inclusion of commercial technologies (such as video over IP) Internet/Intranet connection Integrated CIP motion and safety Redundant controller systems 	EtherNet/IP	19
<ul style="list-style-type: none"> High-speed transfer of time-critical data between controllers and I/O devices Deterministic and repeatable data delivery Media redundancy Intrinsic safety Redundant controller systems 	ControlNet	21
<ul style="list-style-type: none"> Connections of low-level devices directly to plant floor controllers, without interfacing them through I/O modules Data sent as needed More diagnostics for improved data collection and fault detection Less wiring and reduced start-up time than a traditional, hard-wired system 	DeviceNet	22
<ul style="list-style-type: none"> Plant-wide and cell-level data sharing with program maintenance Data sent regularly Transfer of information between controllers 	Data Highway Plus	23
<ul style="list-style-type: none"> Connections between controllers and I/O adapters Data sent regularly Distributed control so that each controller has its own I/O and communicates with a supervisory controller 	Remote I/O	23
<ul style="list-style-type: none"> Fieldbus transmitters and actuators Closed-loop control Process automation 	Foundation Fieldbus	25

For detailed specifications, see the 1756 ControlLogix Network Specifications Technical Data, publication [1756-TD003](#).

EtherNet/IP Communication Modules

EtherNet/IP (Ethernet Industrial Protocol) is an open industrial-networking standard that supports both real-time I/O messaging and message exchange. The EtherNet/IP network uses off-the-shelf Ethernet communication chips and physical media.

Cat. No.	Description	Media	Communication Rate	CIP Motion Axes, max	TCP/IP Connections	Logix Connections
1756-EN2F	EtherNet/IP bridge, fiber	Fiber	100 Mbps	8	128	256
1756-EN2T	EtherNet/IP bridge, copper	Copper	10/100 Mbps	8	128	256
1756-EN2TR	EtherNet/IP bridge, embedded switch, copper	Dual copper	10/100 Mbps	8	128	256
1756-EN3TR	EtherNet/IP bridge, embedded switch, copper	Dual copper	10/100 Mbps	128	128	256
1756-ENBT	EtherNet/IP bridge, copper	Copper	10/100 Mbps	—	64	128
1756-EWEB	Ethernet web server module	Copper	10/100 Mbps	—	64	128
1756-EN2TXT	ControlLogix-XT, extended temperature EtherNet/IP bridge, copper for extreme environments	Copper	10/100 Mbps	8	128	256

Accessories—EtherNet/IP Network

Cat. No.	Description	Specifications
1585J-M8PBJM-x	Ethernet RJ45 patchcord x = 2 (2 m), 5 (5 m) or 10 (10 m)	8 conductor, Teal Riser PVC cable (Flex Rated cable also available)
1585J-M8CC-H	RJ45 insulation displacement connector (IDC)	0.128 . . . 0.325 mm ² (26 . . . 22 AWG), Cat. 6, IDC, no tool required
1585J-M8CC-C	RJ45 crimp connector with boot, qty = 50 pieces	0.128 . . . 0.205 mm ² (26 . . . 24 AWG, Cat. 5e, requires crimp tool for assembly)
1585A-Jcrimp	Crimp tool	—
9300-RADES	Remote access dial-in kit	56 Kbps modem connection to devices on an Ethernet network includes the following: <ul style="list-style-type: none"> • Pre-configured modem • Communication module • DIN rail mounting hardware • Associated cables

Example Configuration—EtherNet/IP Network

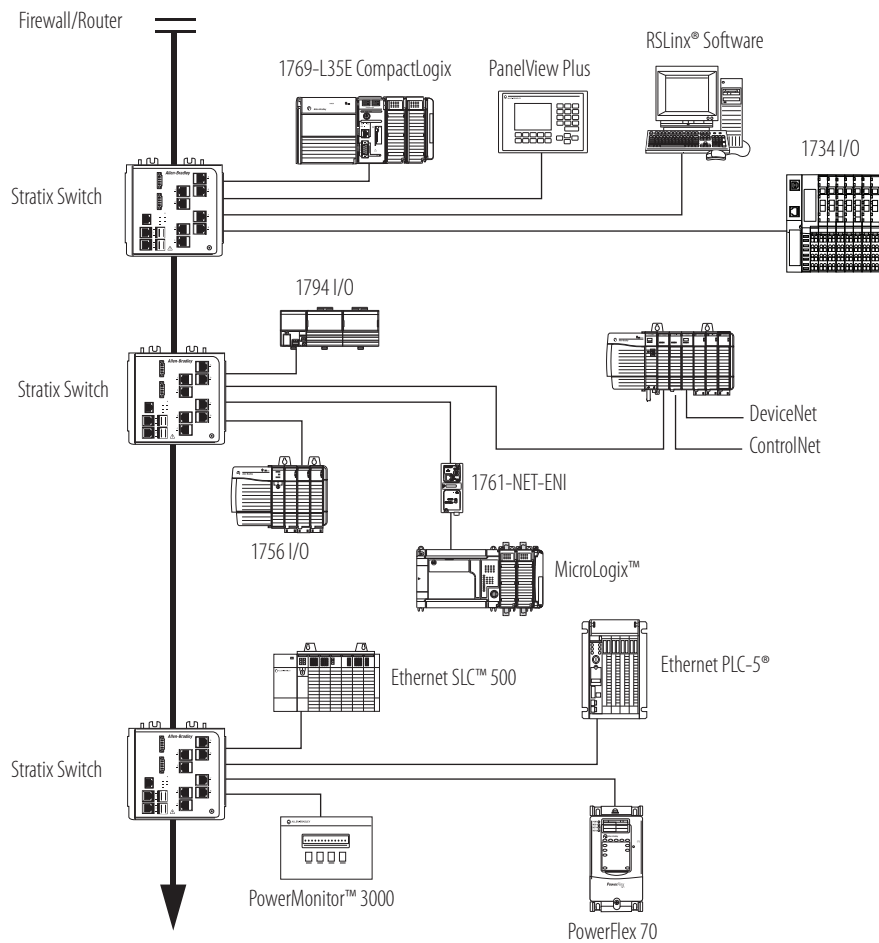

ControlNet Communication Modules

The ControlNet network combines the functionality of an I/O network and a peer-to-peer network, providing high-speed performance. The ControlNet network provides deterministic, repeatable transfers of critical control data.

Cat. No.	Description	Communication Rate	Logix Connections	Number of Nodes
1756-CN2/B	ControlNet bridge, standard media	5 Mbps	128 ⁽¹⁾	99
1756-CN2R/B	ControlNet bridge, redundant media	5 Mbps	128 ⁽¹⁾	99
1756-CNB	ControlNet bridge, standard media	5 Mbps	64 ⁽²⁾	99
1756-CNBR	ControlNet bridge, redundant media	5 Mbps	64 ⁽²⁾	99
1756-CN2RXT	ControlLogix-XT, extended temperature ControlNet bridge, redundant media	5 Mbps	128 ⁽¹⁾	99

(1) 128 connections are available for standard use. An additional three connections are reserved for redundant control.

(2) Recommend using only 40...48 Logix connections for I/O.

Example Configuration—ControlNet Network

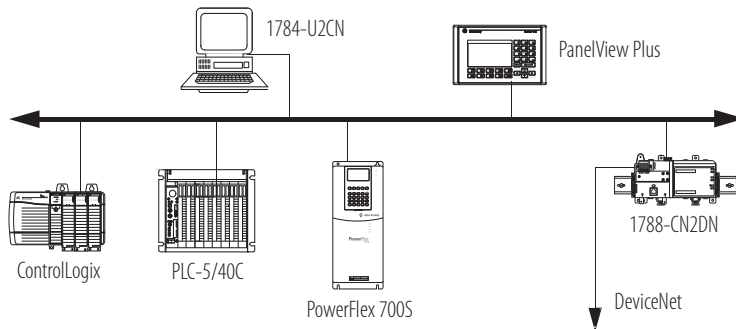

Example Configuration—Redundant ControlNet Media

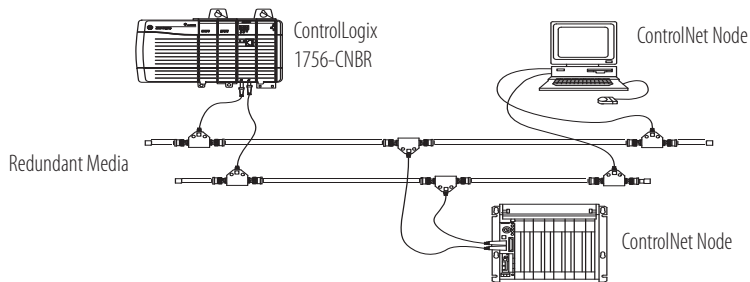

For information on ControlNet media, see the ControlNet Media System Components List, publication [AG-PA002](#).

DeviceNet Communication Module

The DeviceNet network provides connections between simple, industrial devices (such as sensors and actuators) and higher-level devices (such as controllers and computers).

Cat. No.	Description	Communication Rate	Number of Nodes
1756-DNB	DeviceNet bridge	125 Kbps (500 m max) 250 Kbps (250 m max) 500 Kbps (100 m max)	64

Example Configuration—DeviceNet Network

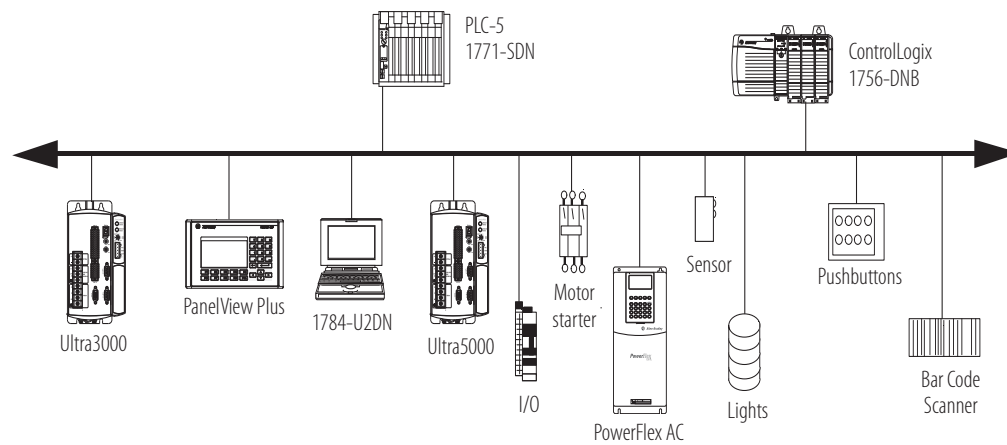

Accessories—DeviceNet Network

Cat. No.	Description
KwikLink™ Lite flat media	KwikLink Lite flat media is a newer, ODVA-approved solution for wiring DeviceNet networks. Drop-lines for connecting nodes are added by using the KwikLink Lite two-piece connectors. This cable system supports the intermixing of DeviceNet cable types (thin-round with flat). All of the KwikLink Lite connectors provide insulation displacement technology with reduced assembly time.
KwikLink flat media	The KwikLink flat media system provides a modular cabling method with its flat 4-wire cable and insulation displacement connectors (IDCs). The KwikLink system allows nodes to be added to the network without severing the trunkline. Cutting or stripping of the trunkline is eliminated, as is the need for predetermined cable lengths.
Round media	Round trunk cable is available in bulk spools or as pre-molded cord sets or patchcords in varying lengths. A wide variety of rugged, durable DeviceNet components is available for use in round trunk systems. Stainless steel versions of round cable system components are also available: <ul style="list-style-type: none"> • Thick-trunk round media systems use thick cable for maximum DeviceNet trunk line length. • Round media thin-trunk systems use thin cable to reduce maximum trunk line distances with a more compact and cost-effective installation for some applications. Thin-cable outer jacket material is TPE for additional chemical resistance.

Data Highway Plus and Remote I/O Communication Modules

The Data Highway Plus network supports messaging between devices. The remote I/O link connects to remote I/O chassis and other intelligent devices.

The 1756-DHRIO module supports messaging between devices on DH+™ networks. The remote I/O functionality enables the module to act as a scanner for transferring digital and block-transfer data to and from remote I/O devices.

The 1756-RIO module can act as a scanner or adapter on a remote I/O network. In addition to digital and block-transfer data, the 1756-RIO module transfers analog and specialty data without message instructions.

Cat. No.	Description	Communication Rate	DH+ Connections	RIO Connections	Maximum Recommended Logix Connections
1756-DHRIO	Data Highway Plus/Remote I/O two-channel communication module	57.6 Kbps, 115.2 Kbps, 230.4 Kbps	32 DH+ messages per DH+ module	Remote I/O scanner only 32 logical rack connections per remote I/O channel 16 block-transfer connections per remote I/O channel	32
1756-RIO	Remote I/O communication module	57.6 Kbps, 115.2 Kbps, 230.4 Kbps	—	Remote I/O scanner or adapter 32 physical racks (0 . . . 76), any combination of rack size and block transfers	10 scheduled I/O
1756-DHRIOXT	ControlLogix-XT, extended temperature Data Highway Plus/Remote I/O two-channel communication module	57.6 Kbps, 115.2 Kbps, 230.4 Kbps	32 DH+ messages per DH+ module	Remote I/O scanner only 32 logical rack connections per remote I/O channel 16 block-transfer connections per remote I/O channel	32

Example Configuration—DH+ Network

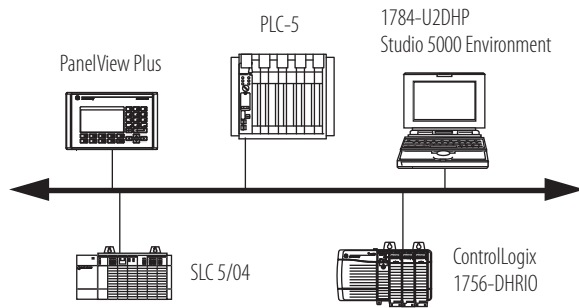

Example Configuration—Remote I/O Network

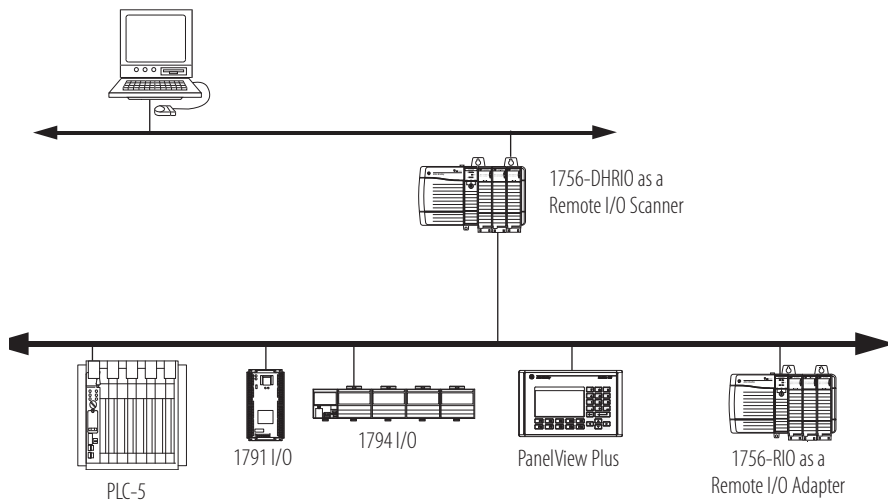

Accessories—DH+ and Remote I/O Networks

Cat. No.	Description	Specifications
1770-CD	Cable to connect communication module to DH+ network	Belden 9463 twinaxial
9300-RADKIT	Remote access dial-in kit	56 Kbps modem connection to devices on a DH+ network includes the following: <ul style="list-style-type: none"> • Pre-configured modem • Communication module • DIN rail mounting hardware • Associated cables

FOUNDATION Fieldbus Linking Devices

The FOUNDATION Fieldbus protocol is a network designed for distributed control of process applications.

Cat. No.	Description	Communication Rate	Number of H1 Ports	Devices per H1 Link	Devices per Linking Device
1757FFLD2	FOUNDATION Fieldbus bridge to an Ethernet network	FOUNDATION Fieldbus: 31.25 Kbps EtherNet/IP: 10/100 Mbps	2	16 (8...10 recommended)	32
1757-FFLD4			4		64
1757-FFLDC2	FOUNDATION Fieldbus bridge to a ControlNet network	FOUNDATION Fieldbus: 31.25 Kbps ControlNet: 5 Mbps	2	16 (8...10 recommended)	32
1757-FFLDC4			4		64

Example Configuration—Bridge to EtherNet/IP Network

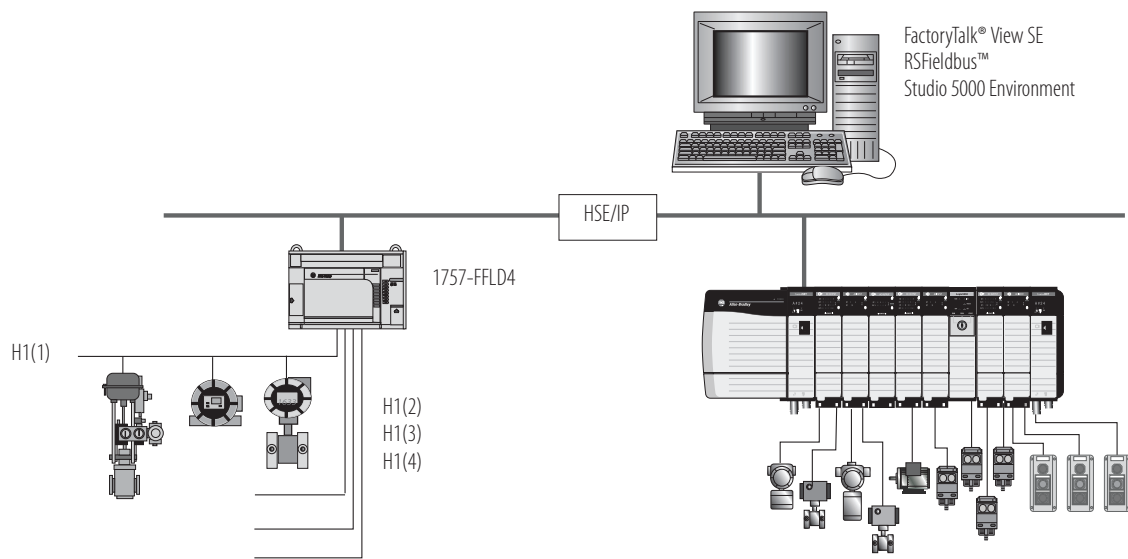

Example Configuration—Bridge to ControlNet Network

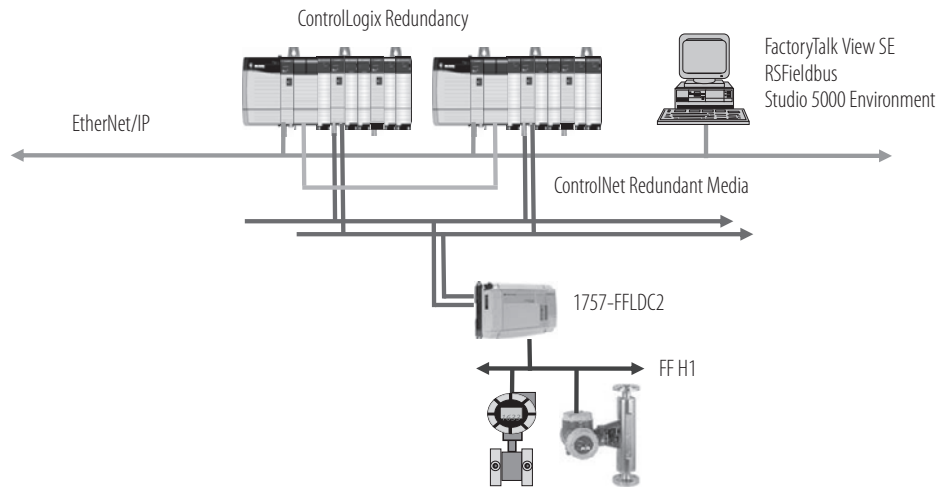

Other Connectivity Options

Option	Consideration
USB connection	The ControlLogix L7 controller has a USB port in place of the serial port. ⁽¹⁾ If your application requires RS-232 functionality, see the many Encompass partners at http://www.rockwellautomation.com/encompass .
Serial connection	The serial port on the 1756-L6 controller is compatible with RS-232 serial communication. The serial port supports the DF1 protocol to communicate with other devices on the serial link. To use Logix5000™ controllers on Modbus, you connect through the serial port and execute a specific ladder logic routine. The controller project is available with the Studio 5000™ Logix Designer application. For more information, see Using Logix5000 Controllers as Masters or Slaves on Modbus Application Solution, publication CIG-AP129 .
DH-485 network	The controller serial port is compatible with DH-485 communication. The DH-485 connection does support remote programming and monitoring via the Logix Designer application. Or, add a 1756-DH485 communication module.
SynchLink network	The SynchLink communication module (1756-SYNCH) provides time synchronization and data broadcasting capabilities for distributed motion and coordinated drive control. The module connects a ControlLogix chassis to a SynchLink fiber-optic communication link.

(1) The USB port is intended for temporary local programming purposes only and not intended for permanent connection. Do not use the USB port in hazardous locations.

ControlLogix Controllers

The ControlLogix controller provides a scalable controller solution that is capable of addressing a large amount of I/O points.

The controller can be placed into any slot of a ControlLogix chassis and multiple controllers can be installed in the same chassis. Multiple controllers in the same chassis communicate with each other over the backplane (just as controllers can communicate over networks) but operate independently.

ControlLogix controllers can monitor and control I/O across the ControlLogix backplane, as well as over I/O links. ControlLogix controllers can communicate over EtherNet/IP, ControlNet, DeviceNet, DH+, Remote I/O, and RS-232-C (DF1/DH-485 protocol) networks and many third party process and device networks. To provide communication for a ControlLogix controller, install the appropriate communication interface module into the chassis.

Cat. No.	Description	User Memory
1756-L71	ControlLogix controller, 1 built-in USB port ⁽¹⁾	2 MB
1756-L72		4 MB
1756-L73		8 MB
1756-L74		16 MB
1756-L75		32 MB
1756-L61	ControlLogix controller, 1 built-in RS-232 port	2 MB
1756-L62		4 MB
1756-L63		8 MB
1756-L64*	*Important: Scan time for a project loaded in a 1756-L64 or 1756-L65 controller may be slower than for the same project loaded in one of the other 1756-L6 controllers. See the Logix5000 Controllers Instruction Execution Time and Memory Use Reference Manual, publication 1756-RM087 , for instruction execution times.	16 MB
1756-L65*		32 MB
1756-L63XT	ControlLogix-XT controller, extreme environment	8 MB
1756-L73XT		8 MB
1756-L61S	GuardLogix safety controller	2 MB standard 1 MB safety
1756-L62S		4 MB standard 1 MB safety
1756-L63S		8 MB standard 3.75 MB safety
1756-L71S		2 MB standard 1 MB safety
1756-L72S		4 MB standard 2 MB safety
1756-L73S		8 MB standard 4 MB safety
1756-LSP		GuardLogix safety partner (one is required for each GuardLogix L6 controller)
1756-L7SP	GuardLogix safety partner (one is required for each GuardLogix L7 controller)	—

(1) The USB port is intended for temporary local programming purposes only and not intended for permanent connection. Do not use the USB port in hazardous locations.

For detailed specifications, see the 1756 ControlLogix Controllers Specifications Technical Data, publication [1756-TD001](#).

Standard ControlLogix Controllers

The ControlLogix controller is part of the Logix5000 family of controllers. A ControlLogix system includes the following:

- The ControlLogix controller, available in different combinations of user memory
- Studio 5000 environment
- 1756 ControlLogix I/O modules that reside in a 1756 chassis
- Separate communication modules for network communication



Feature	1756-L61, 1756-L62, 1756-L63, 1756-L64, 1756-L65	1756-L71, 1756-L72, 1756-L73, 1756-L74, 1756-L75
Controller tasks	<ul style="list-style-type: none"> • 32 tasks • 100 programs/task • Event tasks: all event triggers 	
Built-in communication ports	1 port RS-232 serial	1 port USB
Communication options	<ul style="list-style-type: none"> • EtherNet/IP • ControlNet • DeviceNet • Data Highway Plus • Remote I/O • SynchLink • Third-party process and device networks 	
Built-in port	Serial	USB
Controller connections supported, max	250	500
Network connections, per network module	<ul style="list-style-type: none"> • 256 EtherNet/IP; 128 TCP (1756-EN2x, 1756-EN3x) • 128 EtherNet/IP; 64 TCP (1756-ENBT) • 128 ControlNet (1756-CN2/B, 1756-CN2R/B) • 64 DeviceNet (1756-DNB) 	
Controller redundancy	Full support	
Integrated motion	<ul style="list-style-type: none"> • EtherNet/IP connection • SERCOS interface • Analog options (encoder input, LDT input, SSI input) 	
Programming languages	<ul style="list-style-type: none"> • Relay ladder • Structured text • Function block • Sequential function chart (SFC) 	

ControlLogix-XT Controllers

The ControlLogix-XT controllers function in the same way as the traditional ControlLogix controllers and have the same features as the ControlLogix L6 and L7 controllers.

The ControlLogix-XT products include control and communication system components that are conformally coated to extend product life in harsh, corrosive environments:

- When used with FLEX I/O-XT products, the ControlLogix-XT system can withstand temperatures range from -20...70 °C (-4...158 °F).
- When used independently, the ControlLogix-XT system can withstand temperature ranges from -25...70 °C (-13...158 °F).



Redundant ControlLogix Controllers

The ControlLogix controller supports controller redundancy. In a redundant controller system, you need these components:

- Two 1756 chassis each with the following the same:
 - Number of slots
 - Modules in the same slots
 - Redundancy firmware revisions in each module
 - Two additional ControlNet nodes⁽¹⁾ outside the redundant chassis pair.
- One 1756-RM2 or 1756-RMXT module per chassis that supports the following:
 - One or two ControlLogix or ControlLogix-XT controllers of the same family
 - As many as seven ControlNet or EtherNet/IP communication modules, depending on the firmware revision
- One 1756-RMCx cable

For additional redundancy rules and restrictions, see publication [1756-UM535](#).

(1) For a ControlNet I/O drop, two additional ControlNet nodes are required outside the redundancy chassis pair.

GuardLogix Controllers

A GuardLogix controller is a ControlLogix controller that also provides safety control.



Application	Description
SIL 1, 2, 3	<p>The GuardLogix controller system is type-approved and certified for use in safety applications up to and including SIL 3 according to IEC 61508, and applications up to and including PLe/Cat.4 according to ISO 13849-1. For more information, see the following:</p> <ul style="list-style-type: none"> GuardLogix Controllers Systems Safety Reference Manual, publication 1756-RM093. GuardLogix Controllers User Manual, publication 1756-UM020. GuardLogix Safety Application Instruction Set Reference Manual, publication 1756-RM095.

The GuardLogix system is a dual controller solution. You must use a primary controller and a safety partner to achieve SIL 3/PLe/Cat. 4.



Primary Controller	Safety Partner
1756-L61S, 1756-L62S, 1756-L63S	1756-LSP
1756-L71S, 1756-L72S, 1756-L73S	1756-L7SP
1756-L73SXT	1756-L7SPXT

During development, safety and standard have the same rules, multiple programmers, online editing, and forcing are all allowed. Once the project is tested and ready for final validation, you set the Safety Task to a SIL 3 integrity level, which is then enforced by the GuardLogix controller. When safety memory is locked and protected, the safety logic can't be modified and all safety functions operate with SIL 3 integrity. On the standard side of the GuardLogix controller, all functions operate like a regular Logix controller.

Use Guard I/O modules for field device connectivity on Ethernet or DeviceNet networks, and for safety interlocking between GuardLogix controllers use Ethernet or ControlNet networks. Multiple GuardLogix controllers can share safety data for zone to zone interlocking, or a single GuardLogix controller can use remote distributed safety I/O between different cells/areas.

In addition to the standard features of a ControlLogix controller, the GuardLogix controller has these safety-related features.

Feature	1756-L61S, 1756-L62S, 1756-L63S, 1756-LSP, 1756-L71S, 1756-L72S, 1756-L73S, 1756-L7SP, 1756-L73SXT, 1756-L7SPXT
Safety communication options	<p>Standard and safety</p> <ul style="list-style-type: none"> EtherNet/IP ControlNet DeviceNet
Network connections, per network module	<ul style="list-style-type: none"> 256 EtherNet/IP; 128 TCP (1756-EN2x, 1756-EN3x) 128 EtherNet/IP; 64 TCP (1756-ENBT) 128 ControlNet (1756-CN2/B, 1756-CN2R/B) 64 DeviceNet (1756-DNB)
Controller redundancy	Not supported
Safety Task Programming languages	Relay ladder

Accessories—Controllers

Memory Cards

Memory cards offer nonvolatile memory to permanently store a user program and tag data on a controller. The ControlLogix L7 and GuardLogix L7 controllers ship with 1784-SD1 Secure Digital (SD) card already installed. The ControlLogix L6 and GuardLogix L6 controllers support optional CompactFlash cards that you purchase separately. The memory card installs in a socket on the controller. Through the Logix Designer application, you can manually trigger the controller to save to or load from nonvolatile memory or configure the controller to load from nonvolatile memory on powerup.

Attribute	1784-CF128	1784-SD1	1784-SD2
Memory	128 MB	1 GB	2 GB
Supported controllers	1756 ControlLogix L6 and 1756 GuardLogix L6	1756 ControlLogix L7 and 1756 GuardLogix L7	
Weight, approx.	14.2 g (0.5 oz)	1.76 g (0.062 oz)	

1756 Energy Storage Modules

Instead of a battery, the ControlLogix L7 and GuardLogix L7 controllers ship with a 1756-ESMCAP energy storage module (ESM) already installed.

Cat No.	Description
1756-ESMCAP	Capacitor-based ESM included with the controller.
1756-ESMNSE	ESM without WallClockTime back-up power. Additionally, you can use this ESM with a 1756-L73 (8 MB) or smaller memory-sized controller only. Use this ESM if your application requires that the installed ESM deplete its residual energy to 40 μ J or less before transporting it into or out of your application.
1756-ESMNRM	ESM that secures the controller by permanently preventing the USB connection and SD card use. This ESM provides your application an enhanced degree of security.

The ControlLogix-XT L7 extreme temperature controller ships with a 1756-ESMNCAPXT energy storage module installed.

Cat No.	Description
1756-ESMCAPXT	Capacitor-based ESM included with the controller.
1756-ESMNSEXT	ESM without WallClockTime back-up power. Additionally, you can use this ESM with a 1756-L73XT (8 MB) or smaller memory-sized controller only. Use this ESM if your application requires that the installed ESM deplete its residual energy to 40 μ J or less before transporting it into or out of your application.
1756-ESMNRMXT	ESM that secures the controller by permanently preventing the USB connection and SD card use. This ESM provides your application an enhanced degree of security.

The 1756-L7SP safety partner for a GuardLogix system has the following modules available.

Cat No.	Description
1756-SPESMNSE	Capacitor-based ESM for a GuardLogix safety partner.
1756-SPESMNRM	ESM for a GuardLogix safety partner that secures the safety partner by permanently preventing the USB connection and SD card use.

1756 ControlLogix Batteries

Each ControlLogix 1756-L6 and GuardLogix 1756-L6 controller ships with a battery. With a memory card installed, the controller can be used without a battery. If you do not use a battery, current tag data will be at the state it was when the memory card was saved.

Attribute	1756-BA1	1756-BA2	1756-BATM ⁽¹⁾	1756-BATA
Description	Lithium battery (0.59 g)	Lithium battery (0.59 g)	Externally mounted battery assembly	Replacement lithium battery for 1756-BATM (5 g max lithium per each D cell; contains 2 D cells)
ControlLogix controllers	1756-L61/A, 1756-L62/A, 1756-L63/A	1756-L61/B, 1756-L62/B, 1756-L63/B 1756-L64/B, 1756-L65/B	1756-L61/A, 1756-L62/A, 1756-L63/A	—
GuardLogix controllers	—	1756-L61S, 1756-L62S, 1756-L63S	—	—
ControlLogix-XT controllers	—	1756-L63XT	—	—

(1) The 1756-BATM externally mounted battery assembly is highly recommended for use with all series A, 1756 ControlLogix L6 controllers and provides longer battery life than the 1756-BA1 battery. The 1756-BATM includes one 1756-BATA lithium battery assembly and a 1 m (3.28 ft) cable to connect housing to controller.

ControlLogix Chassis

The ControlLogix system is a modular system that requires a 1756 I/O chassis. Place any module into any slot. The backplane provides a high-speed communication path between modules.

All of the chassis are designed for horizontal-only, back-panel mounting. The chassis are available in these configurations:

- Standard chassis
- ControlLogix-XT chassis

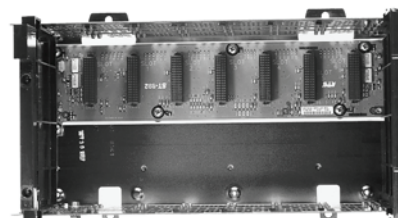

For detailed specifications, see the 1756 ControlLogix Chassis Specifications Technical Data, publication [1756-TD006](#).

Standard Chassis

The chassis backplane provides a high-speed communication path between modules and distributes power to each of the modules within the chassis.

Cat. No.	Description	Slots
1756-A4	Standard chassis	4
1756-A7		7
1756-A10		10
1756-A13		13
1756-A17		17

ControlLogix-XT Chassis

The ControlLogix-XT chassis support extreme temperature environments.

Cat. No.	Description	Slots	Temperature Range
1756-A4LXT	ControlLogix-XT chassis	4	-25...60 °C (-13...140 °F)
1756-A5XT		5	-25...70 °C (-13...158 °F)
1756-A7XT		7	-25...70 °C (-13...158 °F)
1756-A7LXT		7	-25...60 °C (-13...140 °F)

Accessories - Chassis

Use a slot filler module to fill empty slots.

Cat. No.	Description
1756-N2	Slot filler module for empty slots in standard ControlLogix chassis
1756-N2XT	Slot filler module for empty slots in ControlLogix-XT chassis

ControlLogix Power Supplies

ControlLogix power supplies are used with the 1756 chassis to provide 1.2V, 3.3V, 5V, and 24V DC power directly to the chassis backplane. Select from these configurations:

- Standard power supplies
- ControlLogix-XT power supplies
- Redundant power supplies

For detailed specifications, see the 1756 ControlLogix Power Supplies Specifications Technical Data, publication [1756-TD005](#).



Standard Power Supplies

You mount a standard power supply directly on the left end of the chassis, where it plugs directly into the backplane.

Cat. No.	Description	Voltage Category	Operating Voltage Range	Chassis
1756-PA72	Standard AC power supply	120V/220V AC	85...265V AC	Standard, series A and series B
1756-PA75		120V/220V AC	85...265V AC	Standard, series B
1756-PB72	Standard DC power supply	24V DC	18...32V DC	Standard, series A and series B
1756-PB75		24V DC	18...32V DC	Standard, series B
1756-PC75		48V DC	30...60V DC	Standard, series B
1756-PH75		125V DC	90...143V DC	Standard, series B

ControlLogix-XT Power Supplies

The ControlLogix-XT power supplies support extreme temperature environments.

Cat. No.	Description	Voltage Category	Operating Voltage Range	Chassis
1756-PAXT	ControlLogix-XT AC power supply	85...265V AC	120/240V AC	XT
1756-PBXT	ControlLogix-XT DC power supply	24V DC	18...32V DC	XT

Redundant Power Supplies

A redundant power supply system provides additional uptime protection for chassis used in critical applications. The redundant power supplies funnel power through the chassis adapter module to the ControlLogix Series B chassis backplane. To build a redundant power supply system you need the following components.

Cat. No.	Amount	Description	Voltage Category	Operating Voltage Range	Chassis
1756-PAR2	Kit	Bundled system contains: - Two 1756-PA75R power supplies - Two 1756-CPR2 cables - One 1756-PSCA2 chassis adapter module	110V AC	N/A	Standard, series B
1756-PBR2	Kit	Bundled system contains: - Two 1756-PB75R power supplies - Two 1756-CPR2 cables - One 1756-PSCA2 chassis adapter module	24V DC	N/A	
1756-PA75R/A or 1756-PB75R/A	2	Redundant AC power supply Redundant DC power supply	120V/220V AC 24V DC	85...256V AC 19.2...32V DC	
1756-CPR2	2	Redundant power supply cable (Length = 0.91 m [3 ft])	N/A	N/A	
1756-PSCA2	1	Redundant power supply chassis adapter module			
N/A (user-supplied)	2	Annunciator wiring ⁽¹⁾ (Maximum length = 10 m [32.8 ft])			

(1) Optional user-supplied annunciator wiring can be connected to the solid state relay for status and troubleshooting purposes.

Visualization Products

Visualization products, together with Logix for control and NetLinx architecture for communication, make up the Rockwell Automation Integrated Architecture™ strategy. The visualization strategy combines Rockwell Automation expertise in Allen-Bradley® electronic operator interface and industrialized personal computer hardware with Rockwell Software® supervisory control software. Current visualization products include the following:

- FactoryTalk View software
- PanelView Plus operator interface
- PanelView Plus CE operator interface
- Industrial computers and monitors

For more information, see the Operator Interface catalog pages at <http://www.ab.com/en/epub/catalogs/12762/2181376/1239781/>.

Programming Software

Your selection of modules and network configuration determines what software packages you need to configure and program your system.

Studio 5000 Environment

The Studio 5000™ Engineering and Design Environment combines engineering and design elements into a common environment. The first element in the Studio 5000 environment is the Logix Designer application. The Logix Designer application is the rebranding of RSLogix™ 5000 software and will continue to be the product to program Logix5000™ controllers for discrete, process, batch, motion, safety, and drive-based solutions.



The Studio 5000 environment is the foundation for the future of Rockwell Automation® engineering design tools and capabilities. It is the one place for design engineers to develop all the elements of their control system.

1756 System Software

If you have	You need	Order
1756 ControlLogix controller	Studio 5000 Logix Designer application	9324 series ⁽¹⁾
1756 SERCOS or analog motion module		
1756-CN2, 1756-CN2R 1756-CN2RXT 1756-CNB, 1756-CNBR ControlNet communication module	RSNetWorx™ for ControlNet software	9324 series ⁽¹⁾ (RSNetWorx option) or 9357-CNETL3 (RSNetWorx for ControlNet)
1756-DNB DeviceNet communication module	RSNetWorx for DeviceNet software	9324 series ⁽¹⁾ (RSNetWorx option) or 9357-DNETL3 (RSNetWorx for DeviceNet)
1756-EN2F, 1756-EN2T 1756-EN2TX 1756-EN2TR, 1756-EN3TR 1756-ENBT, 1756-EWEB EtherNet/IP communication module (set the IP address)	RSLink software or BOOTP/DHCP server utility to set IP addresses Optional RSNetWorx for EtherNet/IP software	9324 series ⁽¹⁾ Optional 9357-ENETL3 (RSNetWorx for EtherNet/IP)
1756-DHRIQ, 1756-DHRIOX communication module 1756-DH485 communication module	RSLink software	9324 series ⁽¹⁾
1757-FFLD2, 1757-FFLD4 1757-FFLDC2, 1757-FFLDC4 Foundation Fieldbus linking device	RSFieldbus configuration software	9308 series
Communication card in a workstation	RSLink software	9324 series ⁽¹⁾

(1) All 9324 packages include RSLink Classic Light.

Studio 5000 Logix Designer Application

To use the Logix Designer application effectively, your personal computer must meet the following hardware and software requirements for the Studio 5000 environment, version 21.00.00.

Hardware Requirements

The personal computer must meet these minimum requirements. Using a computer meeting or exceeding the recommended characteristics will improve performance.

Characteristic	Minimum	Recommended
Processor	Pentium 4	Intel Core i5
Speed	2.8 GHz	2.4 GHz
RAM memory	1 GB	8 GB
Hard disk space	16 GB free	20 GB free
Graphics device	1024x768, true color	DirectX 9, with WDDM 1.0 or higher driver

Software Requirements

Operating system and service pack compatibility is as follows:

- This version of Logix Designer has been tested on the following operating systems:
 - Microsoft Windows 7 Professional (64-bit) with Service Pack 1
 - Microsoft Windows 7 Home Premium (64-bit) with Service Pack 1
 - Microsoft Windows 7 Home Premium (32-bit) with Service Pack 1
 - Microsoft Windows Server 2008 R2 Standard Edition with Service Pack 1
- This version of the Logix Designer application has not been tested but is expected to operate correctly on all other editions and service packs of the following operating systems:
 - Microsoft Windows 7
 - Microsoft Windows Server 2008 R2
- For operating systems that support User Account Control (UAC), this version of the Logix Designer application was tested with UAC set to the most restrictive level ("Always notify" for Windows 7). This version of the Logix Designer application is also expected to operate correctly when UAC is configured for any less restrictive setting.
- Running the Logix Designer application in conjunction with Fast-User Switching, in Safe mode, or via Remote Desktop is not supported.

Additional Software Product Considerations

Additional software compatibility is as follows:

- FactoryTalk Services Platform, version 2.51 or later is not required to run the Logix Designer application; however, it is required in order to perform some security functions in the Logix Designer application.
- RSLinx Classic communication software is not required to install the Logix Designer application; however, it is required in order to perform online communication with controllers.
- RSLinx Classic version 3.51.00 is a component aligned to Logix Designer, version 21.00.00. RSLinx Classic, version 3.51.00 (CPR9 Service Release 5.1) has been tested, and is compatible, with the following products:
 - FactoryTalk Services Platform, version 2.51.00
 - RSLinx Enterprise, version 5.51.00
 - RSNetWorx software, version 21.00.00
 - FactoryTalk Activation Manager, version 3.51.00
- RSLinx Classic, version 3.51.00, Logix Designer application, version 21.00.00, and device profiles that ship with the Logix Designer application, version 21.00.00 are not compatible with these products:
 - RSNetWorx software, version 11.00.00 or earlier
 - DeviceNet Tag Generator, version 11.0.20.0

RSNetWorx software and the DeviceNet Tag Generator must be upgraded prior to installing these products.
- FactoryTalk View SE (CPR 9) software and RSLinx Enterprise communication software are not required to install the Logix Designer application; however, these products are required to fully use the alarm capabilities introduced with version 16.03.00.
- Be sure to check the software requirements for other Rockwell Software products that you intend to install to be sure that these products are also compatible with the system.

Allen-Bradley, Rockwell Automation, Rockwell Software, ArmorBlock, CompactBlock, CompactLogix, ControlLogix, ControlLogix-XT, Data Highway Plus, DH+, DriveExecutive, Encompass, FactoryTalk, FLEX Ex, FLEX, FLEX I/O-XT, FlexLogix, Guard I/O, GuardLogix, Integrated Architecture, Kinetix, KwikLink, Logix5000, MicroLogix, PanelView, PLC-5, PhaseManager, POINT Guard I/O, POINT I/O, PowerFlex, PowerMonitor, RSFieldbus, RSLinx, RSLogix, RSNetWorx, SLC, SoftLogix, Stratis 8000, SynchLink, StepForward, Ultra, 1336 Plus, and LISTEN.THINK.SOLVE. are trademarks of Rockwell Automation, Inc.

Trademarks not belonging to Rockwell Automation are property of their respective companies.

www.rockwellautomation.com

Power, Control and Information Solutions Headquarters

Americas: Rockwell Automation, 1201 South Second Street, Milwaukee, WI 53204-2496 USA, Tel: (1) 414.382.2000, Fax: (1) 414.382.4444

Europe/Middle East/Africa: Rockwell Automation NV, Pegasus Park, De Kleetlaan 12a, 1831 Diegem, Belgium, Tel: (32) 2 663 0600, Fax: (32) 2 663 0640

Asia Pacific: Rockwell Automation, Level 14, Core F, Cyberport 3, 100 Cyberport Road, Hong Kong, Tel: (852) 2887 4788, Fax: (852) 2508 1846